

# Doppelstockzelt 10 m - 35 m

## Dual-level tent 10 m - 35 m

### Erdgeschoss / Ground floor

**Spannweite / Span**  
10,00 m - 35,00 m

**Traufhöhe / Height of eaves**  
3,70 m

**Firsthöhe / Height of the roof ridge**  
10,00 m

**Stützenraster / Support grids**  
5,00 m x 5,00 m

**Hauptprofil / Main profile**  
Stahl doppel T Profil verzinkt / Steel girder galvanised

**Eckverbindung / Corner connections**  
Stirnplatten / Plate connectors

**min. Länge / min. length**  
15,00 m

**max. Länge / max. length**  
unbegrenzt / unlimited

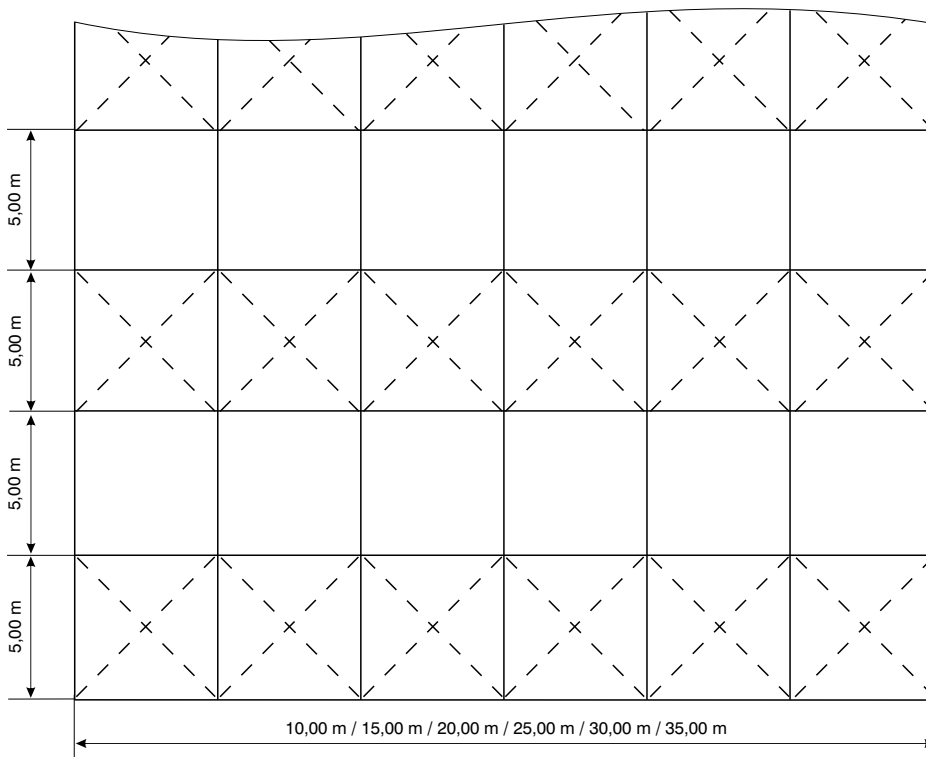
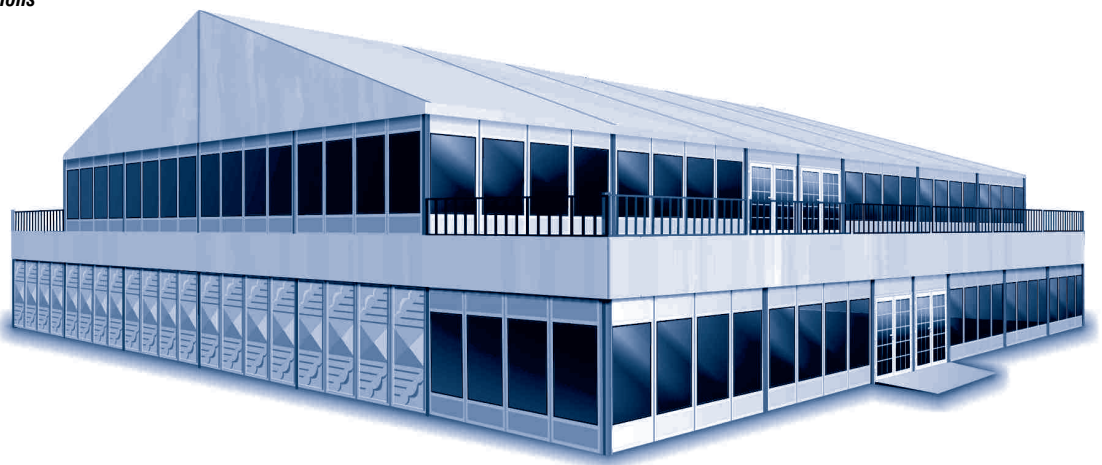
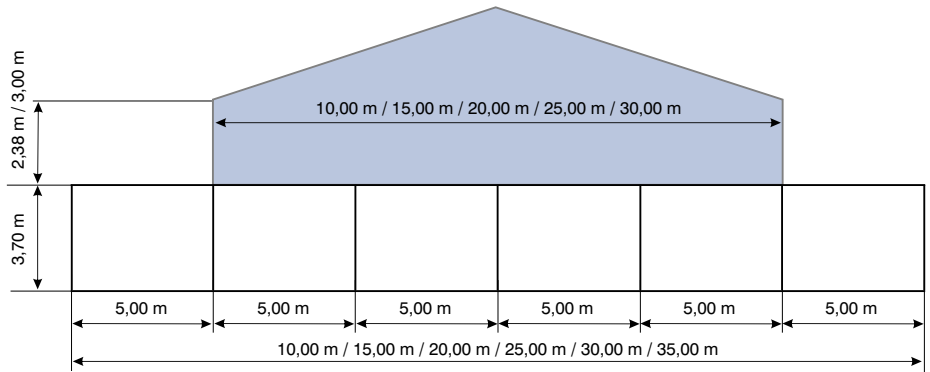

### Fußbodensysteme / Floor systems

Kassettenfußboden

Cassette flooring

### Variationen / Variations

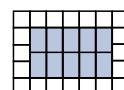
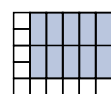
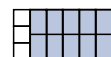

# Bogenzelt 10 m (Doppelstock)

## Roundroof tent 10 m (Dual-Level)

BOZ 10/3,00-A

ESCHENBACH.  
TENTSYSTEMS

### Obergeschoss / first floor:

Spannweite / Span  
10,00 m

Traufhöhe / Height of eaves  
3,00 m

Firsthöhe / Height of the roof ridge  
4,34 m

Längstes Bauteil / Longest component  
10,00 m

Binderabstand / Bay distance  
5,00 m

Giebeleinteilung / Gable composition  
1 Giebelstütze / 1 gable support

Gewicht / Weight  
ca. 7,5 kg/m<sup>2</sup>

Hauptprofil / Main profile  
140 x 100 x 3 mm

Eckverbindung / Corner connections  
Knotenbleche  
Plate connector

min. Länge / min. length  
15,00 m

max. Länge / max. length  
unbegrenzt / unlimited

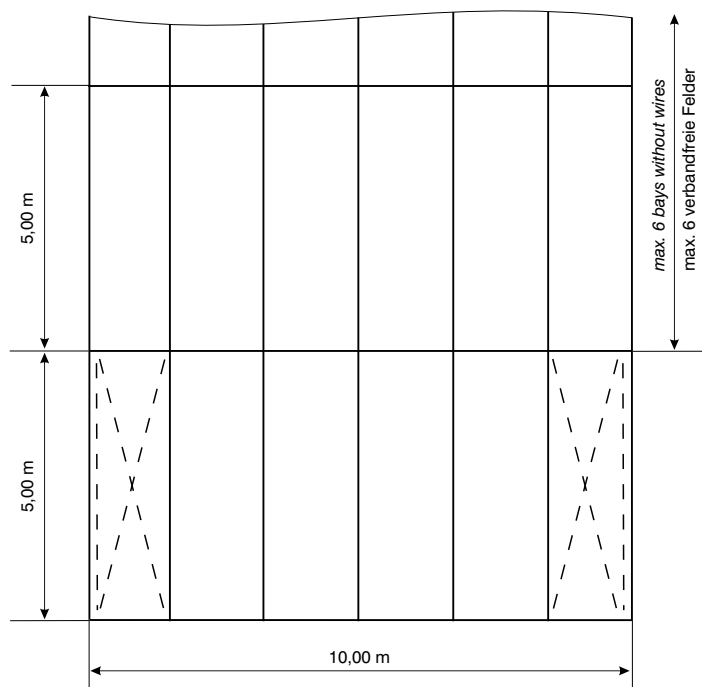
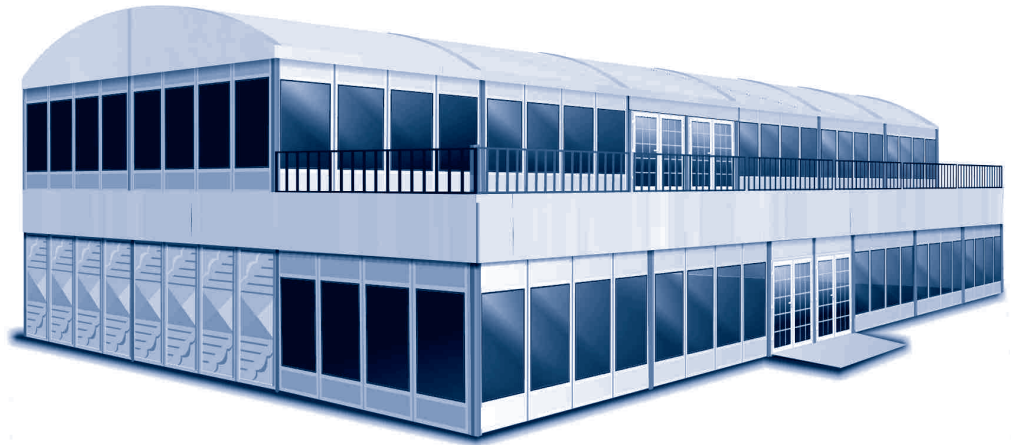
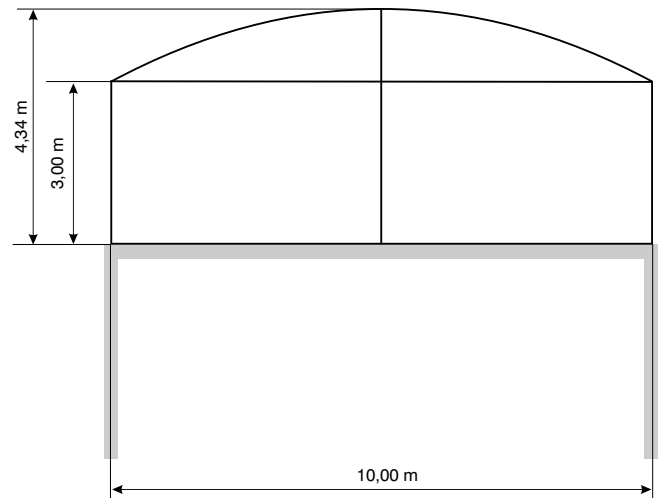

# Doppelstock Pagode 6-eck 8 m / 10 m

## Dual-level Pagoda 6-sided 8 m / 10 m

DPG 6-eck 08/5,38-A  
DPG 6-eck 10/5,38-A

ESCHENBACH.  
TENTSYSTEMS

**Spannweite / Span**  
8,00 m / 10,00 m

**Schlüsselweite / Width of facing sides**  
6,93 m / 8,66 m

**Traufhöhe / Height of eaves**  
5,38 m

**Firsthöhe / Height of the roof ridge**  
9,95 m / 9,45 m

**Längstes Bauteil / Longest component**  
5,50 m

**Binderabstand / Bay distance**  
4,00 m / 5,00 m

**Hauptprofil Obergeschoss / Main profile upper floor**  
128 x 70 x 2,5 mm

**Maximal Last Obergeschoss / Maximum load upper floor**  
350 kg/m<sup>2</sup>

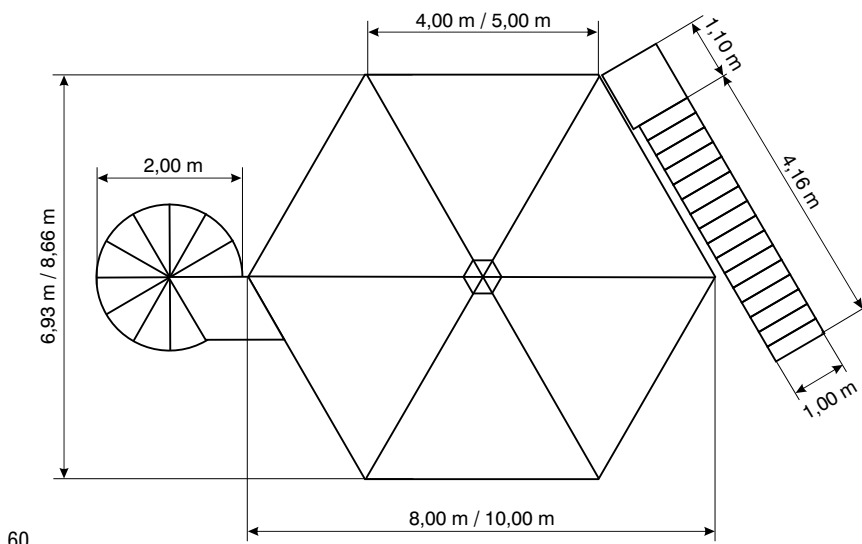
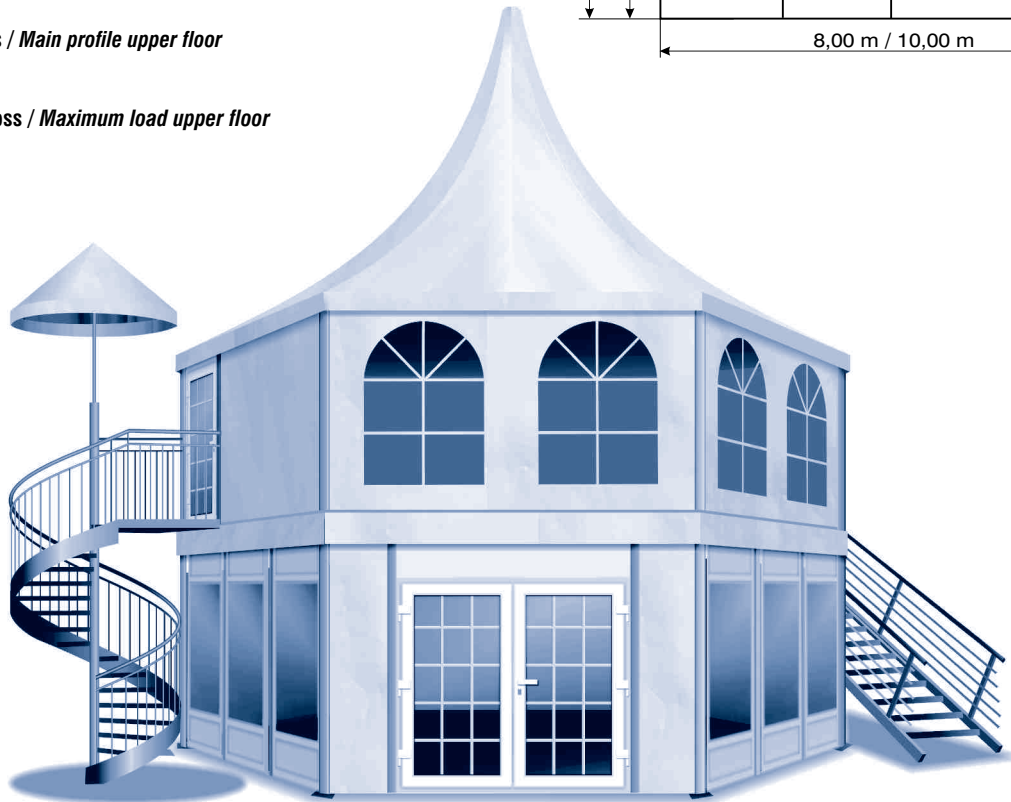
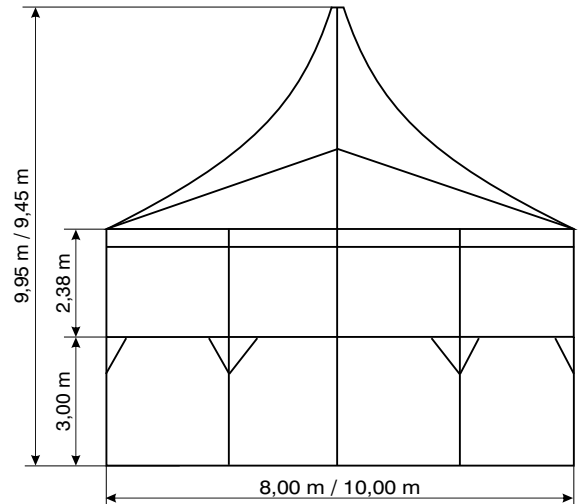

### Fußbodensysteme / Floor systems

Holzfußboden

Wooden flooring

# Doppelstock Pagode 8-eck 15 m

## Dual-level Pagoda 8-sided 15 m

DPG 8-eck 15/6,70-A

ESCHENBACH.  
TENTSYSTEMS

**Spannweite / Span**  
15,00 m

**Schlüsselweite / Width of facing sides**  
13,89 m

**Traufhöhe / Height of eaves**  
6,70 m

**Firsthöhe / Height of the roof ridge**  
12,30 m

**Längstes Bauteil / Longest component**  
8,00 m

**Binderabstand / Bay distance**  
5,74 m

**Maximal Last Obergeschoss / Maximum load upper floor**  
500 kg/m<sup>2</sup>

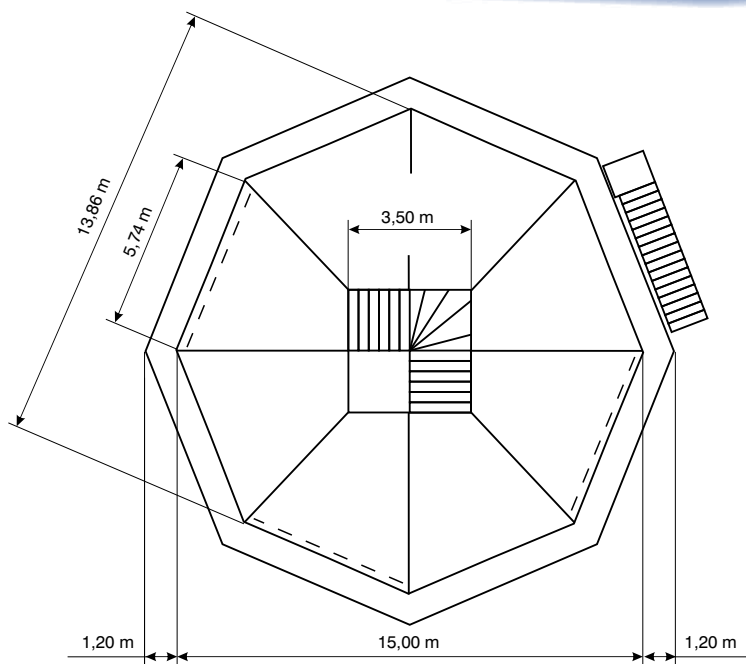
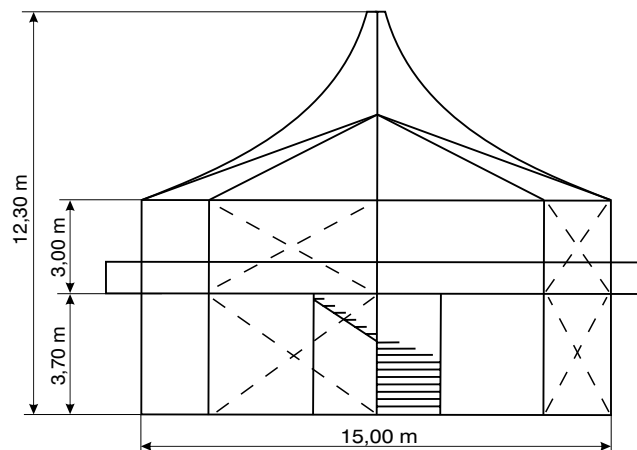

### Fußbodensysteme / Floor systems

Kassettenfußboden

Cassette flooring